

## Features

- Assemblage design, sturdy structure, magnetically shielded
- High inductance, high current, low magnetic loss, low ESR, small parasitic capacitance
- Flat, round and litz wire version to optimize the DC & AC losses
- Temperature rise current and saturation current is less influenced by environment
- Operating temperature: -40°C to +125°C



## Application

- Storage inductor for high efficiency DC/DC converters with high ripple currents
- Filter for audio applications
- CRM, CCM & DCM PFC Stages

## Product Identification

KHF    2013   -   2R2   M

①                      ②                      ③                      ④

①	Type
KHF	Wire Wound SMD Power Inductor

②	External Dimensions (L×W×H) [mm]
2013	21.8x22.5x14.5
2818	27.9x27.9x17.8

③	Nominal Inductance
example	Nominal Value
2R2	2.2 uH

④	Inductance Tolerance
example	Nominal Value
M	±20%

## SHAPE AND DIMENSIONS

### KHF2013-M Series

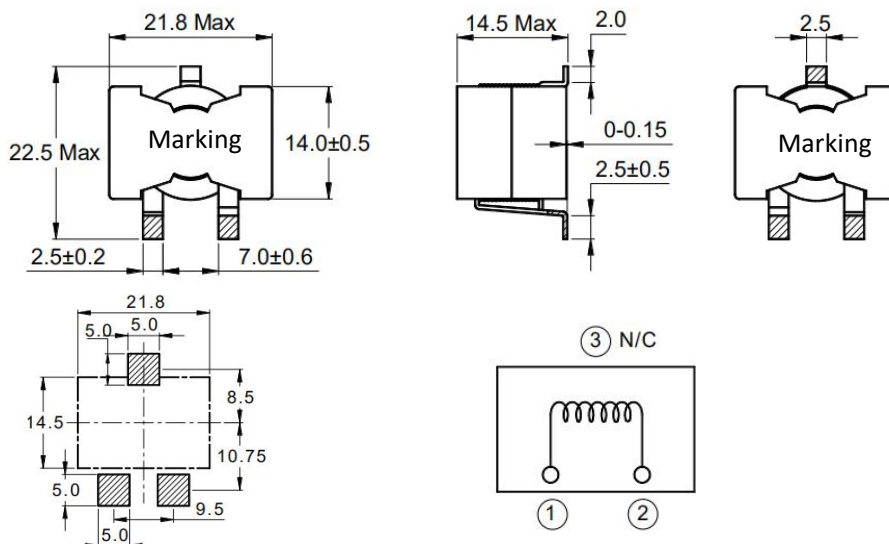

## KHF2818-M Series

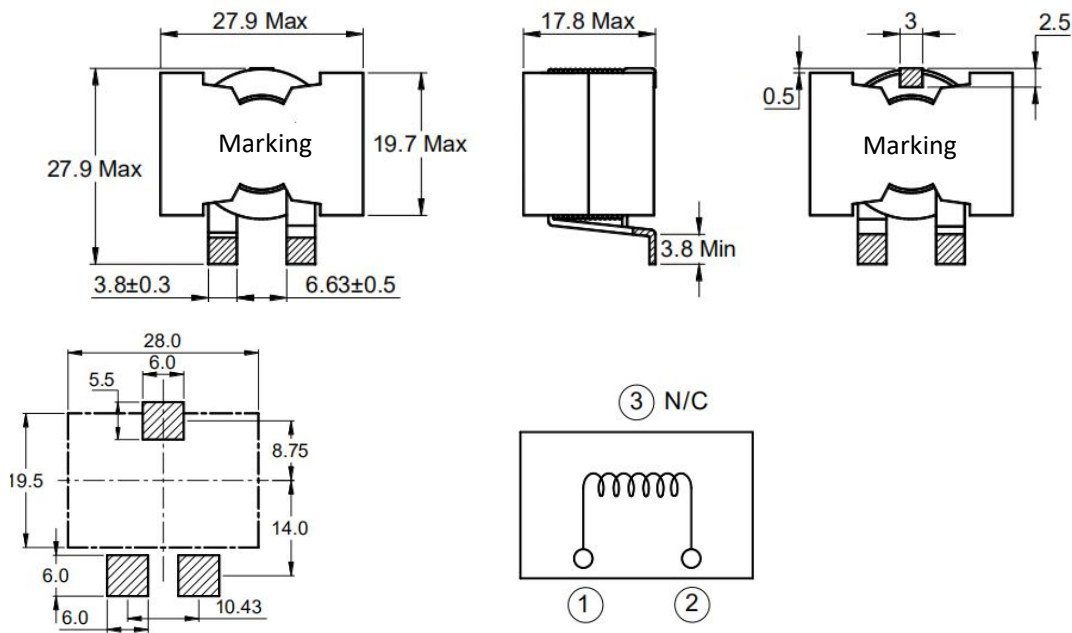

## SPECIFICATIONS

### KHF2013 series

Part Number	Inductance ±20%	DC Resistance		Saturation Current*3	Heat Rating Current *4
	@100KHz 0.1v	Typ.	Max.	Typ.	Typ.
units	uH	mΩ		A	A
Symbol	L	DCR		Isat	Irms
KHF2013-2R2MC	2.20	1.70	2.20	55.0	28.0
KHF2013-2R7MC	2.70	1.70	2.20	48.0	28.0
KHF2013-3R3MC	3.30	3.28	3.80	48.0	24.0
KHF2013-4R7MC	4.70	3.28	3.80	35.0	24.0
KHF2013-5R6MC	5.60	3.28	3.80	30.0	24.0
KHF2013-6R8MC	6.80	6.60	7.30	34.0	18.0
KHF2013-8R2MC	8.20	6.60	7.30	29.0	18.0
KHF2013-100MC	10.0	6.60	7.30	23.0	18.0
KHF2013-150MC	15.0	8.60	9.50	18.0	16.0
KHF2013-220MC	22.0	8.60	9.50	13.0	16.0
KHF2013-330MC	33.0	8.60	9.50	9.00	16.0

## KHF2818 series

Part Number	Inductance ±20%	DC Resistance		Saturation Current*3	Heat Rating Current *4
	@100KHz 0.1v	Typ.	Max.	Typ.	Typ.
units	uH	mΩ		A	A
Symbol	L	DCR		Isat	Irms
KHF2818-1R0MC	1.00	0.50	0.60	120	60.0
KHF2818-1R5MC	1.50	0.72	0.87	110	50.0
KHF2818-2R2MC	2.20	0.72	0.87	85.0	50.0
KHF2818-3R3MC	3.30	2.60	2.86	91.0	28.0
KHF2818-4R7MC	4.70	2.60	2.86	61.2	28.0
KHF2818-6R8MC	6.80	2.60	2.86	45.0	28.0
KHF2818-100MC	10.0	2.60	2.86	31.2	28.0
KHF2818-150MC	15.0	2.60	2.86	21.2	28.0
KHF2818-220MC	22.0	2.60	2.86	14.0	28.0
KHF2818-330MC	33.0	2.60	2.86	8.70	28.0

- All data is tested based on 25°C ambient temperature
- Inductance measure condition at 100kHz,0.1V
- Saturation current: the actual value of DC current when the inductance decrease 20% of its initial value
- Temperature rise current: the actual value of DC current when the temperature rise is  $\Delta T 50^{\circ}\text{C}$  ( $T_a=25^{\circ}\text{C}$ )
- Special remind: Circuit design, component placement, PWB size and thickness, cooling system and etc
- All will affect the product temperature. Please verify the product temperature in the final application

## TYPICAL ELECTRICAL CHARACTERISTICS

### KHF 2013 Series

Saturation current VS temperature rise current curve

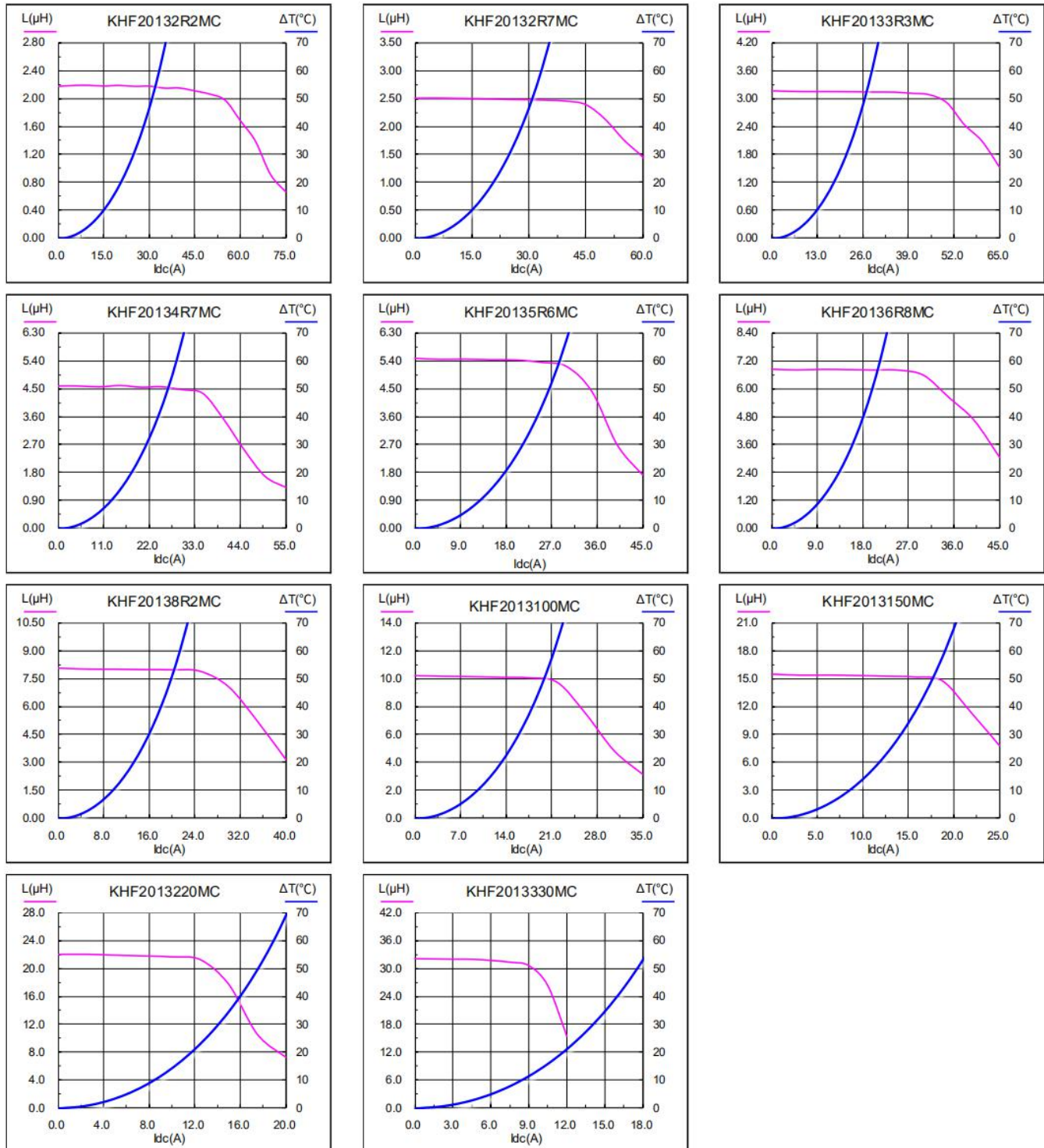

Saturation current VS temperature rise current curve

# Wire Wound SMD Power Inductor-KNR Series

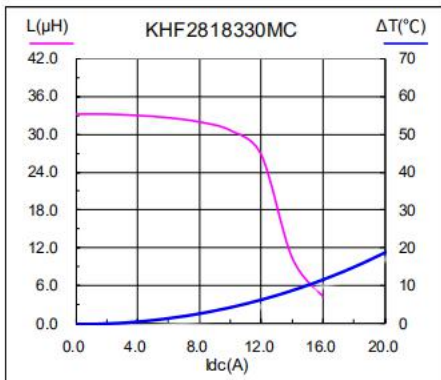
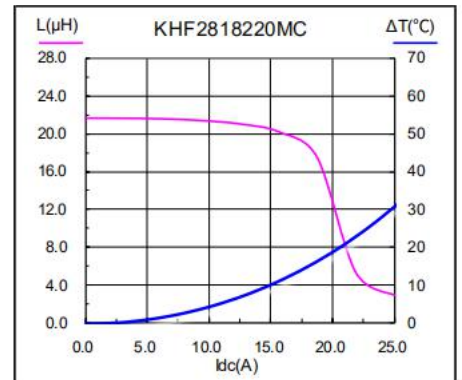
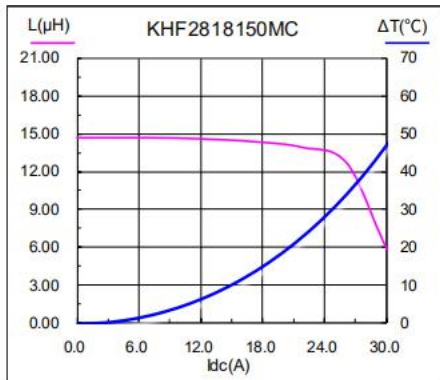
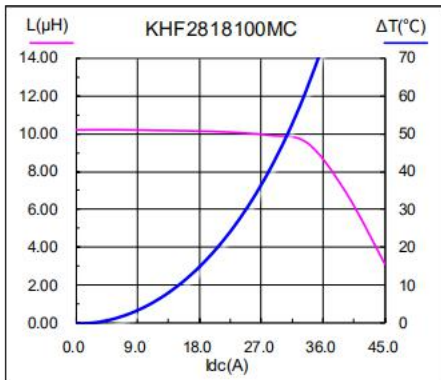
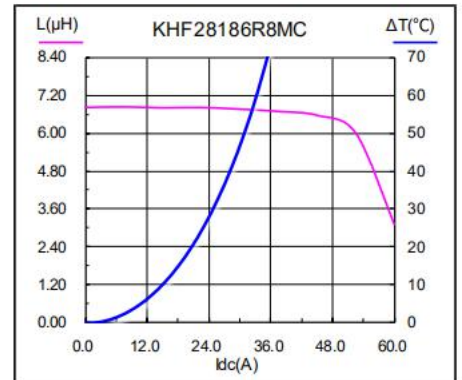
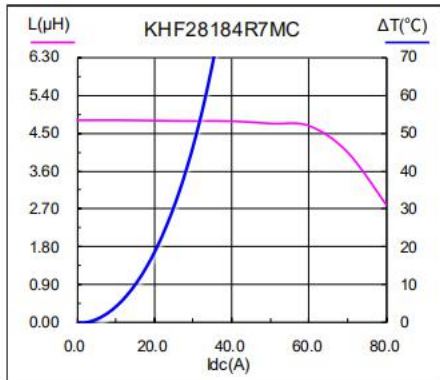
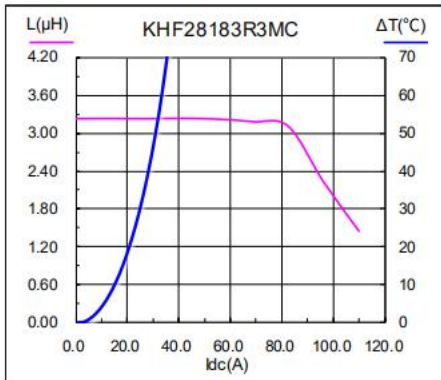
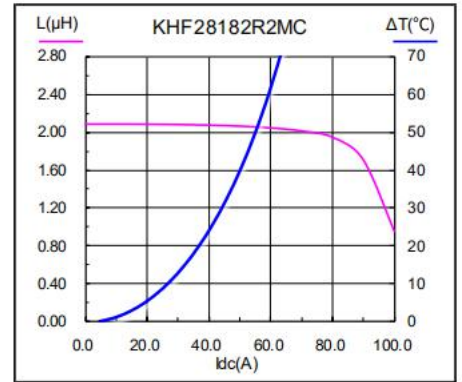
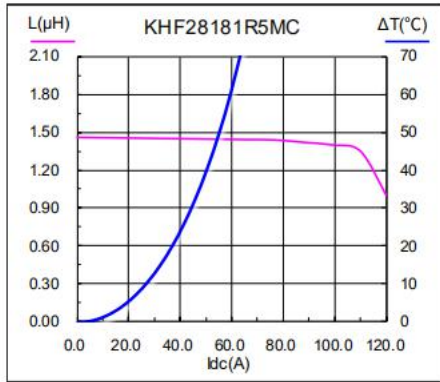
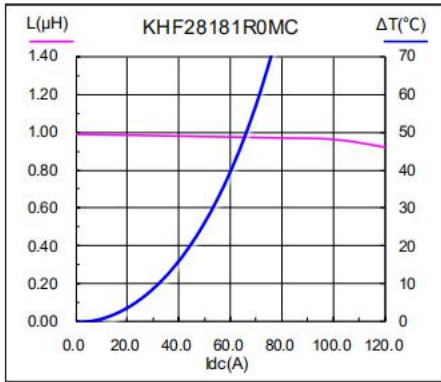

## SOLDERING SPECIFICATION

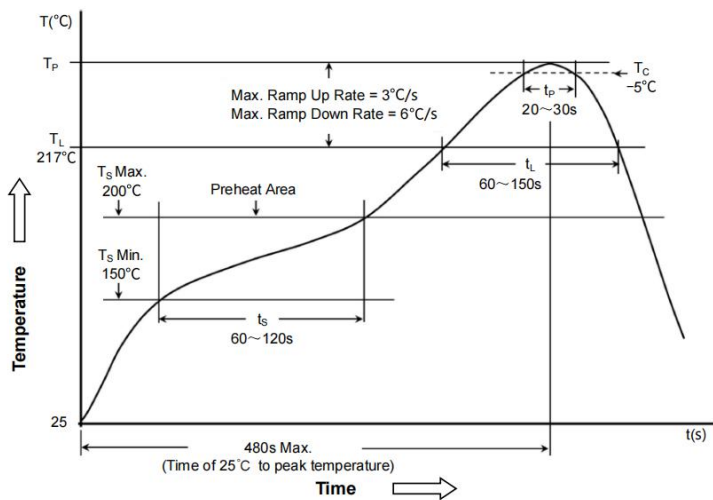

	Package Thickness	Package Volume		
		<350 mm <sup>3</sup>	350~2000 mm <sup>3</sup>	>2000 mm <sup>3</sup>
PB-Free Assembly	<1.6mm	260 °C	260 °C	260 °C
	1.6~2.5mm	260 °C	250 °C	245 °C
	≥2.5mm	250 °C	245 °C	245 °C

- Reflow is referred to standard IPC/JEDEC J-STD-020D

## NOTICE OF USE

- Product in packing storage condition : temperature 5~40°C, RH<=70%;
- storage of KONEN Electronic products for longer than 12 months is not recommended, Within other effects, the terminals may suffer degradation, resulting in bad solderability. Therefore, all products shall be used within the period of 12 months based on the day of shipment;
- Do not keep products in unsuitable storage conditions, such as areas susceptible to high temperatures, high humidity, dust or corrosion;
- Always handle products with care;
- Don't touch electrodes directly with bare hands as oil secretions may inhibit soldering. Always ensure optimum conditions for soldering;
- When this product will be used on a similar or new project to the original one, sometimes it might be unable to satisfy the specifications due to different condition of usage;
- This inductor itself does not have any protective function in abnormal condition, such as overload, short-circuit, open-circuit conditions, etc. Therefore, it shall be confirmed that there is no risk of smoke, fire, dielectric withstand voltage, insulation resistance, etc., or use in abnormal conditions protective devices or protection circuit in the end product;
- Hi-Pot test with higher voltage than spec value will damage insulating material and shorten its life;
- If using in potting compound, the magnet wire coating might be damaged, please consult with us;
- Refrain from rinsing coils. If necessary, please consult with us.